

Mounting Channels

Universally slotted H-profile mounting channel

Material specifications	
Material	DX51D or Equivalent steel DD11 or Equivalent steel
Coatings	Galvanized, Hot-Dip Galvanized (HDG), Powder Coating*, Zinc Magnesium*



Applications

- Installation of medium to heavy-duty ventilation ducts, plumbing & firefighting pipes and cable trays
- Secondary support structure for installation of different services

Features & Benefits

- Wide range of mounting options in conjunction with our FXC mounting channel accessories
- Quick and efficient attachment of multiple support structure
- Lateral and vertical adjustment with reliable fastening
- High load bearing capacity owing to special material properties and design

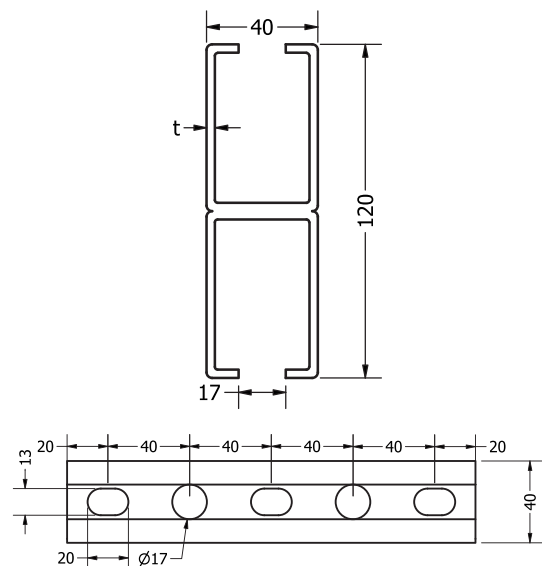

Select Variant

Article No.		Product Description	L (mm)	W (mm)	H (mm)	t (mm)
Galvanized (vz)	HDG (fvz)					
300230	300231	FXC Mounting Channel 40 120 3, 6 m	6000	40	120	3.0
300240	300241	FXC Mounting Channel 40 120 3, 3 m	3000	40	120	3.0
300250	300251	FXC Mounting Channel 40 120 3, 2 m	2000	40	120	3.0

*Available on request